

Clarion

Pro Video TV Tuner

TTX7101

Owner's Guide

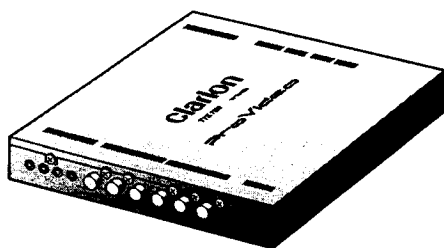

ProVideo

Introduction 5-11

Please be sure to read this page before using the unit.

Installation and Connections 12-17

Please read this page when installing the unit.

Operation of the TV Mode with the Card Remote Control 18-27

Please read this page with regard to connections between this unit and the source unit, when deck connections are made, or when FM modulator connections are made.

- This connection method should be used with the VMA9181 PRO VIDEO LCD monitor. Operation is not possible with monitors made by other companies.
- Operation in the TV mode is by means of the card remote control packaged with the special add-on kit FM modulator accessory package for TV tuner (RCB-062-600) which is available as an option.
 - * Connections with the monitor should be checked by referring to "System Connections Examples" on Page 12 and "System Wiring Check Table" on Page 14.
 - * Connections with the source unit should be checked by referring to "System Connections Examples" on Page 12 and "System Wiring Check Table" on Page 14.

When C-BUS wiring has been used, operation in the TV mode is by means of the source unit. For details, see the owner's manual of the source unit.

Miscellaneous 28-29

Contents

PRECAUTIONS	5
Before Using the Unit	6
Major Specifications	9
Product Contents	10
Name of the Parts	11
System Connections Examples	12
System Wiring Check Table	14
Installation Method	15
Power Cable Connections	16
Operation of the TV Mode with the Card Remote Control	18
Names and Functions of the Card Remote Control	19
Viewing TV Broadcasts	20
Storing Channels to Preset Memory	21
Station Selection	23
Viewing a Video	24
Convenient Functions	25
Troubleshooting	28
Specifications	29

PRECAUTIONS

This equipment has been tested and found to comply with the limits for a Class B digital device, pursuant to Part 15 of the FCC Rules. These limits are designed to provide reasonable protection against harmful interference in a residential installation. This equipment generates, uses, and can radiate radio frequency energy and, if not installed and used in accordance with the instructions, may cause harmful interference to radio communications.

However, there is no guarantee that interference will not occur in a particular installation. If this equipment does cause harmful interference to radio or television reception, which can be determined by turning the equipment off and on, the user is encouraged to consult the dealer or an experienced radio/TV technician for help.

CHANGES OR MODIFICATION NOT EXPRESSLY APPROVED BY THE MANUFACTURER FOR COMPLIANCE COULD VOID THE USER'S AUTHORITY TO OPERATE THE EQUIPMENT.

MONITOR AND TUNER MUST BE INSTALLED AND USED ONLY IN ACCORDANCE WITH THESE INSTRUCTIONS. FAILURE TO DO SO MAY CAUSE DAMAGE TO THE VEHICLE OR THE UNIT, MAY RESULT IN AN ACCIDENT, AND MAY VIOLATE THE LAW. CLARION DISCLAIMS ANY LIABILITY FOR ANY DAMAGES THAT MAY RESULT FROM A FAILURE TO INSTALL AND USE THIS UNIT AS STATED IN THESE INSTRUCTIONS.

Before Using the Unit

Safety Precautions

Warning!

- Safety first! For rear seat use only. Do not install monitor on dashboard or anywhere else that would permit monitor to be viewed by the driver. Monitor must not be installed in the motor vehicle at any point forward of the back of the front seats. *Monitor must never be used in any manner that will distract driver or interfere with driver's safe operation of the motor vehicle.*
- This unit is designed to be used in a vehicle having a 12 V DC negative ground. Do not use it in a 24 V DC vehicle such as a large truck, or a diesel vehicle with cold district specifications. *Doing so will cause fire or breakdown.*
- Do not disassemble this unit or modify it. *Doing so might lead to an accident, fire, or electric shock.*
- Do not use the unit when there is no picture or no sound. *Doing so might lead to an accident, fire, or electric shock.*
- When replacing a fuse, be sure to use one of the specified capacity (Amperes). Use of a fuse with a rating larger than the specified capacity can cause a fire.
- In the event of an irregularity such as foreign matter entering the unit, water entering the unit, or smoke or a strange smell coming from the unit, stop using the unit immediately and be sure to contact your store of purchase. Continuing to use the unit as is might lead to an accident, fire, or electric shock.

Caution!

- Use a volume level while driving which will not hinder the hearing of sounds outside the vehicle. Driving with the volume too high to permit sounds outside the vehicle from being heard can lead to an accident.
- Do not use this unit other than in mobile applications. *Doing so might lead to electric shock or injury.*

Handling Precautions

Caution!

- When the temperature in the vehicle is high, such as in summer, the remote control should be stored in a cool place not

exposed to direct sunlight. Leaving the remote control in a hot place will lead to its breakdown or a malfunction.

- Never disconnect or connect the connection coupler while the system is operating. *Doing so will lead to breakdown.*
- Moisture, high temperatures and high humidity are unfavorable for the unit. Please be careful with matters of cleaning in the vehicle and ventilation.
- Do not put anything or plug anything into unused jacks. *Doing so will lead to breakdown.*

Precautions for Battery Use

Warning!

- Keep the battery of the remote control out of the reach of children to prevent accidents. Should your child swallow a battery, call a doctor immediately.

Caution!

- Do not use batteries other than the type specified. *Doing so may lead to fire or injury due to battery explosion or leakage.*
- Pay attention to polarity (the positive (+) terminal and the negative (-) terminal) when inserting the battery into the unit and follow the indications. A mistake could lead to injury due to battery explosion or leakage.
- Do not carry or store batteries together with items made of metal such as metal ballpoint pens, necklaces, or coins. *Doing so might result in the positive (+) and negative (-) terminals of the battery short circuiting which can cause a fire or injury due to battery explosion or leakage.*
- Do not heat, disassemble, or place batteries in cold water. *Doing so may lead to fire or injury due to battery explosion or leakage.*
- Dispose of used batteries in established places.

Precautions for Installation

Warning!

FOR REAR SEAT USE ONLY. DO NOT INSTALL MONITOR ON DASHBOARD OR ANYWHERE ELSE THAT WOULD PERMIT MONITOR TO BE VIEWED BY THE DRIVER. MONI-

TOR MUST NOT BE INSTALLED IN THE MOTOR VEHICLE AT ANY POINT FORWARD OF THE BACK OF THE FRONT SEATS. MONITOR MUST NEVER BE USED IN ANY MANNER THAT WILL DISTRACT DRIVER OR INTERFERE WITH DRIVER'S SAFE OPERATION OF THE MOTOR VEHICLE.

- Do not install this unit where it will block the driver's field of view, or where it will obstruct driving operations or where it will present a danger to passengers. Doing so may lead to traffic accidents or injury.
- When holes are to be drilled in the vehicle chassis for the purpose of installation, check for the position of pipes, tanks, and electrical distribution and take care not to interfere or make contact with such places. Failing to do so may lead to fire or damage.
- Disconnect the negative-side cable of the battery when performing wiring work. Failing to do so may lead to electric shock or injury due to a short-circuit accident.
- Cable types should be in agreement with the indications of the System Connections Examples and the cables should be gathered so as not to hinder driving operations. Failing to do so might result in cables becoming wrapped on the steering wheel, shift lever, or brake pedal, which is dangerous.
- When making a ground connection using a chassis bolt or nut, do not use one belonging to a safety feature such as one related to steering, seat rails, or the brake system. Doing so could lead to an accident or damage.
- Do not cut the sheath of the power supply leads and use them as the power source of other equipment. The current capacity of the leads might be exceeded which could lead to fire or electric shock.

Caution!

- Installation of this unit or installation changes should be requested from your store of purchase for the sake of safety. Special technology and experience is necessary.
- Be sure to use the supplied parts as specified. Use of parts other than those specified can result in damage to the parts inside the unit, or the unit may shift since it cannot be securely fastened; such conditions can cause an accident or break-

down.

- Do not install the unit where it can be rained upon, exposed to water, or in a place that is subject to a lot of moisture or dust. Penetration into this unit of water, moisture or dust can be the cause of smoke or fire.
- Do not install the unit where there is a lot of vibration or in places where the unit cannot be securely fastened. Doing so might result in the shifting of the unit and could cause an accident or injury.
- When installing the unit using chassis bolts or nuts, never use any belonging to a safety feature such as those related to steering, seat rails, brake system, or gas tank. Doing so could lead to a braking malfunction or breakdown and could cause a fire.
- Do not install the monitor to the ceiling or any other unstable location. Doing so could result in the monitor falling and causing an accident or injury.
- Observe standard connections. Failing to do so could cause a fire or an accident.
- Do not route wiring to movable parts such as portions of the chassis, near screws or seat rails. Doing so might result in a broken cable or short circuit which could cause an accident, electric shock, or fire.

Reception

- When receiving TV broadcasts, a household TV antenna can be fixed in an ideal direction, but since a vehicle is mobile, reception is affected by obstacles such as buildings and mountains which cause the signal strength to change and this may result in poor reception.
- Upon moving away from the broadcast area, the signal becomes weak and the reception conditions worsen. UHF stations and local stations have low broadcast signal output and the reception conditions can worsen with a movement of several kilometers.
- External factors such as high voltage lines, and traffic lights can result in picture disturbances and the introduction of noise.

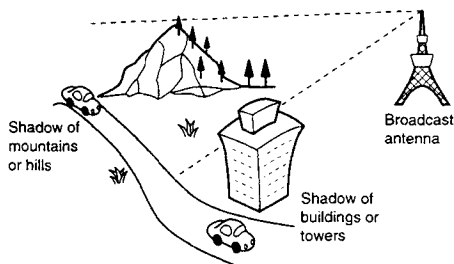

Cleaning

- Wipe with a dry, soft cloth. When very soiled, moisten a soft cloth with neutral detergent that has been diluted with water and wipe lightly, then finish with a dry cloth.

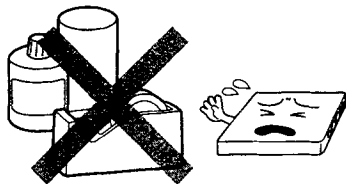

Reference:

Wiping with a hard cloth, and the use of benzene, thinner, or alcohol will damage the surface of the unit as well as lead to breakdown and, therefore, should not be used.

Major Specifications

■ Three Types of Wiring Permitted

Three types of wiring can be used with this unit: C-BUS (digital two-way communications system) wiring, deck wiring, and FM modulator wiring, which enable the use of Clarion source units and mobile FM radios, etc.

■ Quick Tuning to Your Desired Broadcast Stations

Preset tuning (for a total of 12 VHF/UHF stations), manual tuning, and automatic tuning (using auto presets) permit easy tuning of the desired broadcast stations on your outing.

■ Stereo Broadcast Reception

You can enjoy listening to programs broadcast in stereo.

■ Four-System Diversity Built In

The connection of optional sub-antennas permits four-system diversity reception.

■ CD (MD) Auto Changer Connection Jacks

Systems wired with C-BUS or deck wiring can accept the direct connection of a CD (MD) auto changer.

■ Video/Audio (Stereo) Input Jacks

Equipped with two sets of input jacks permitting the connection of VTRs and video cameras.

■ Display Function when Using Audio

This function displays the operation conditions at the time of using audio when the following source units are connected:

- ARX9170
- ARX8170
- DRX9175L

Product Contents

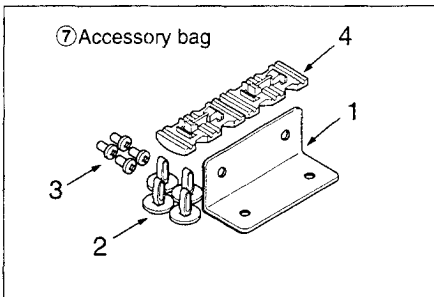
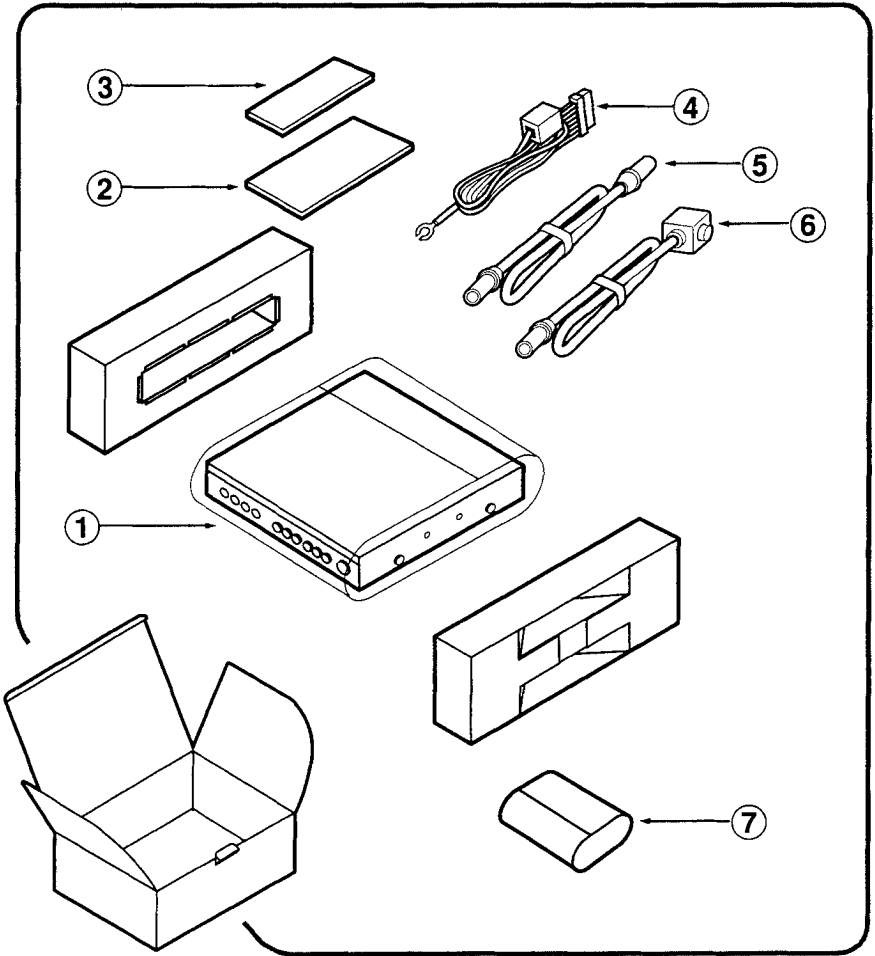

① Main unit	1
② Owner's Guide	1
③ Warranty	1
④ Power cable	1
⑤ 6-pin mini DIN cable	1
⑥ 13-pin DIN cable	1
⑦ Accessory bag	1
1. Mounting bracket	2
2. Canoe clip	4
3. Mounting screws (M4 x 8)	4
4. Electro Tap	2

Names of the Parts

Right Side

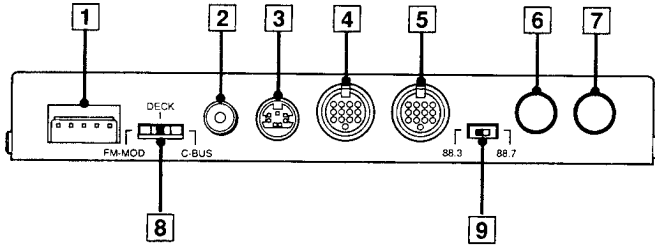

- | | |
|-------------------|--------------------------------|
| 1 Power connector | 6 Radio antenna in |
| 2 Video out | 7 Radio antenna out |
| 3 Monitor out | 8 Position switch |
| 4 Changer | 9 Oscillation frequency switch |
| 5 Source unit | |

Left Side

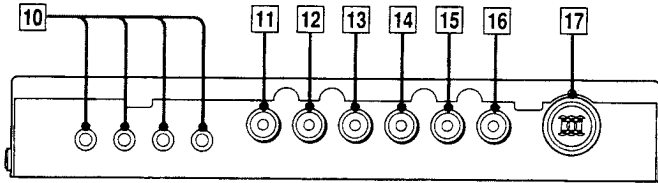

- | | |
|---|---|
| 10 Diversity antenna in | 14 VTR in 2 (Yellow video jack) |
| 11 VTR in 1 (Yellow video jack) | 15 VTR in 2 (White left-channel audio jack) |
| 12 VTR in 1 (White left-channel audio jack) | 16 VTR in 2 (Red right-channel audio jack) |
| 13 VTR in 1 (Red right-channel audio jack) | 17 Option |

System Connections Examples

Before Making Connections

- This unit cannot be used alone. Please use it in conjunction with a Clarion source unit or mobile FM radio.
- The connection method for this unit will differ depending on the source unit that is to be connected. Refer to the connection examples and check the connection method, then connect properly.
- Wiring of an FM modulator requires the connection cable packaged with the optional FM modulator accessory package for the TV tuner (RCB-062-600).

Examples of Connections to the Right-side Jacks

*1 Position Switch

Please change the position switch setting depending on the connection method. The unit will not operate with an incorrect setting.

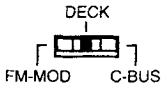

*2 Frequency Switch

When FM modulator wiring is used, there is the possibility of receiving interference from FM broadcast stations. Change the position of the oscillation frequency switch (as required).

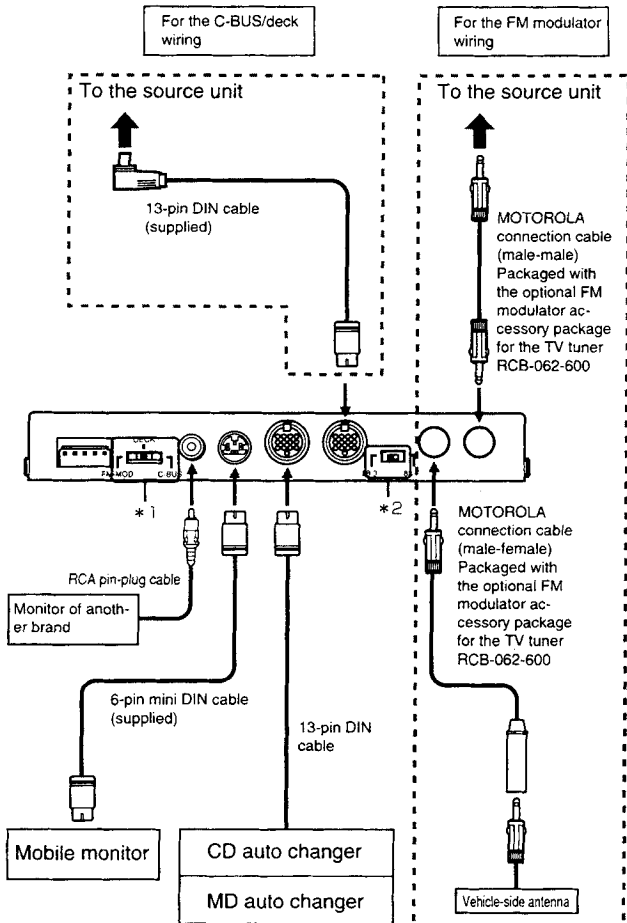
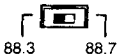

Examples of Connections to the Left-side Jacks

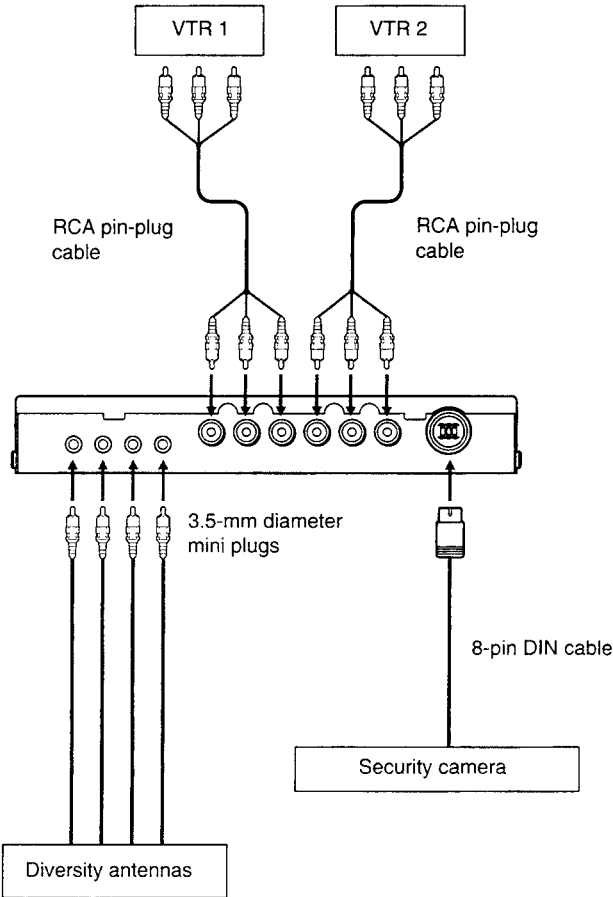

System Wiring Check Table

This System Wiring Check Table is current as of June 1995. For information concerning connection of the latest models or clarification of any points, please contact your store of purchase, or a Clarion service depot, or a customer service center.

Source Unit Connections

The source units that can be connected using each of the wiring types are listed below.

- Source Units Connected by C-BUS Wiring
ARX8170 ARX9170 DRX9175L
- Source Units Connected by Deck Wiring
ADX8155
- Source Units Connected by FM Modulator Wiring
Wiring is possible if the antenna input jack is a MOTOROLA jack of the source unit with mobile FM radios or built-in FM tuners.

CD (MD) Changer Connections

- CD (MD) changers that can be connected to this unit are as follows:
CD (MD) Changers
CDC1805/CDC1205/CDC605/MDJ-474, 2060, 2040

Monitor Connections

- Monitors that can be connected to this unit are as follows:
VMA9181 and other monitor brands
Only the C-Bus wiring permits connection and use of other monitor brands. When another type of wiring is used, please use the VMA9181.

Security Camera Connections

Security Camera Connections

The optional CAA-147 power box is required when using the CC-100F security camera. (For details, see the owner's manual of the security camera.)

- Security cameras that can be connected to this unit are as follows:
CC-100F

Installation Method

Before Installing

FOR REAR SEAT USE ONLY. DO NOT INSTALL MONITOR ON DASHBOARD OR ANYWHERE ELSE THAT WOULD PERMIT MONITOR TO BE VIEWED BY THE DRIVER. MONITOR MUST NOT BE INSTALLED IN THE MOTOR VEHICLE AT ANY POINT FORWARD OF THE BACK OF THE FRONT SEATS. MONITOR MUST NOT BE INSTALLED IN A LOCATION OR IN A MANNER WHICH COULD DISTRACT DRIVER OR INTERFERE WITH DRIVER'S SAFE OPERATION OF THE MOTOR VEHICLE.

- Before installing to the vehicle, consider the overall operation and safety of the system and set the installation location.
- The screws and other parts used for the installation should be the supplied items that are packaged with the unit. Use of items other than those supplied can cause breakdown.
- Attention should be paid to the following points and the wiring performed securely for the routing of the harness at the time of installing and wiring the unit.
 - * Avoid hot places (especially near the heater duct).
 - * Choose a place with good airflow where the unit will not be exposed to water.
 - * When vehicle noise is received, further distance the cables from the car-side wiring.

Example of Installation Under the Seat

- ① Install the mounting brackets to the sides of the unit with the supplied mounting screws (M4 x 8).
- ② Determine the installation position of the unit above the floor mat and open holes in the floor mat to match the holes on the bottom of the mounting brackets.
- ③ From the bottom of the floor mat, insert the supplied canoe clips into the holes on the bottom of the mounting brackets.

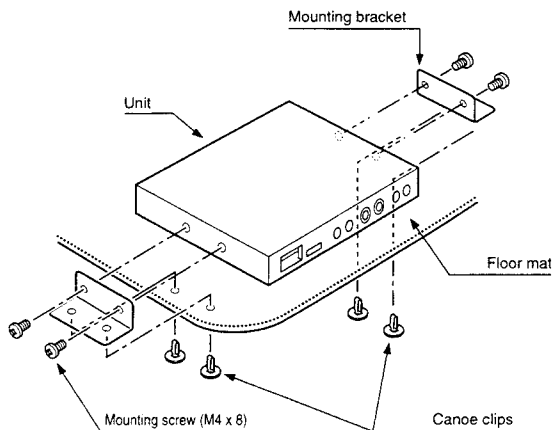

Power Cable Connections

Warning!

Accident Prevention

When it is time to make connections, first switch off the ignition key and disconnect the negative (-) terminal of the battery as a safety measure against a short circuit.

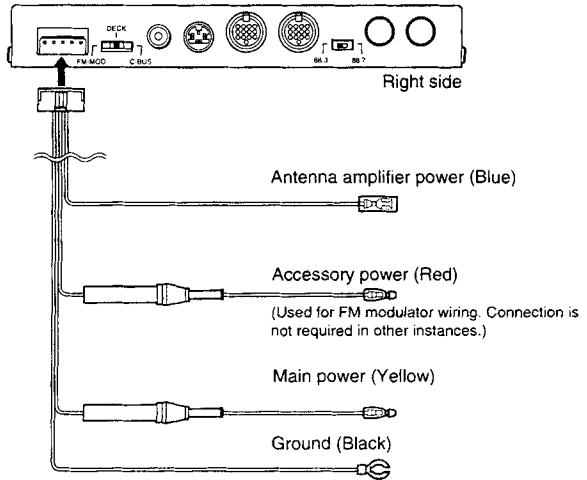

Accessory Power Cable and Main Power Cable Connections

Be sure to connect the (red) accessory power cable and the (yellow) main power cable to the specified places. Connection to the same place will cause a breakdown.

When connection cannot be made with terminals, use the supplied Electro Tap to make the connection as illustrated in the diagram.

The accessory power supply is only used for FM modulator wiring.

As illustrated in the diagram, the intermediate cable is brought against the stopper and bent back in the direction of the arrow sign.

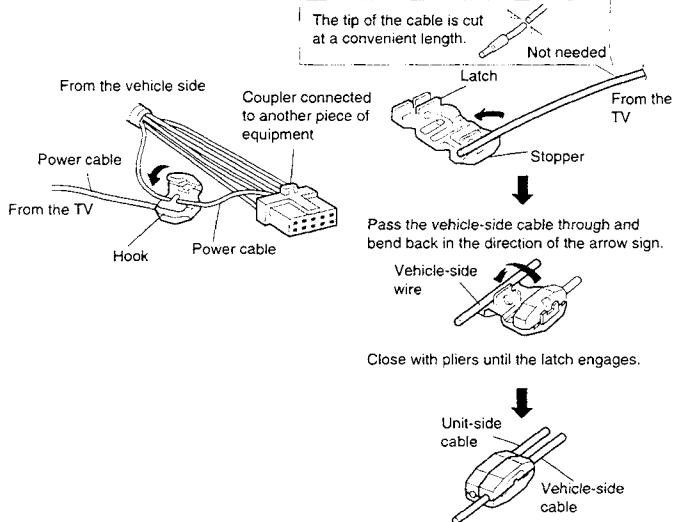

Antenna Amplifier Power Connections

The antenna amplifier power supply (blue lead) is used to supply the power of the mobile TV antenna equipped with built-in amplifier. For details, please read the antenna owner's manual.

After completing the wiring, bind with clamps or insulating tape to protect the cable.

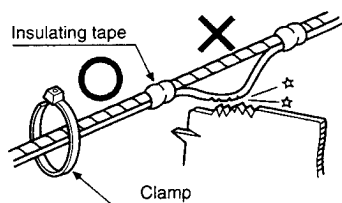

Operation of the TV Mode with the Card Remote Control

When connections of the main unit and the source unit have been made with deck wiring and FM modulator wiring, operation in the TV mode is performed with the card remote control, which is packaged with the FM modulator accessory package for the TV tuner (RCB-062-600).

- This connection method should be used with the VMA9181 PRO VIDEO Type 6 LCD monitor. Operation is not possible with monitors made by other companies.
 - * Connections with the monitor should be checked by referring to "System Connections Examples" on Page 12 and "System Wiring Check Table" on Page 14.
 - * Connections with the source unit should be checked by referring to "System Connections Examples" on Page 12 and "System Wiring Check Table" on Page 14.

When C-BUS wiring has been used, operation in the TV mode is by means of the source unit. For details, see the owner's manual of the source unit.

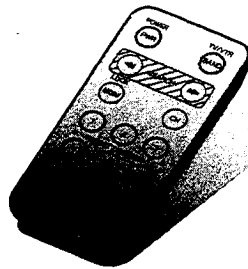

Names and Functions of the Card Remote Control

Warning!

For Safety, the driver must not operate the Remote Control while operating the vehicle. To do so may be a driving hazard.

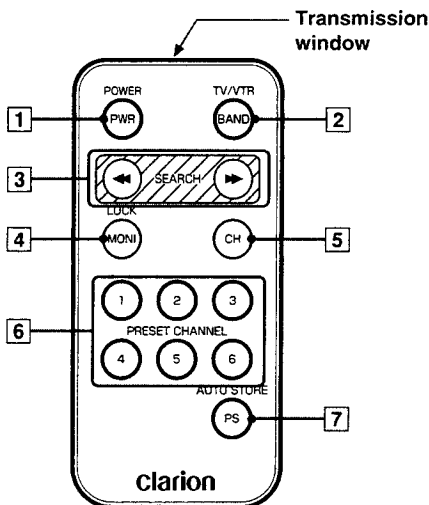

1 Power button

2 Band button

3 Channel buttons

4 Monitor/Monitor lock button

Used to switch the screen on and off, and to lock the monitor.

5 Channel display button

Used to switch the channel display on and off, and to switch the broadcast mode.

6 Preset channel button

7 Preset scan/Auto store button

Precautions in Using the Card Remote Control

- Please replace the battery of the card remote control when the transmission distance becomes shorter or when the range of operation becomes narrower.
- Do not leave the card remote control in places that reach high temperatures or in places exposed to direct sunlight. Doing so will cause the remote control to breakdown or become misshapen. (The storage temperature is from -10°C to $+60^{\circ}\text{C}$.)
- The transmission window of the remote control should be directed at the remote control sensor window of the monitor and operated in a 30' range up/down and left/right.

Installing the Battery

- 1 Turn over the remote control, push the lock tab located at the bottom side in the direction of the arrow, and while doing so, pull off the cover.
- 2 Insert the supplied battery (CR2025) with the (+) side up.
- 3 Push in the cover until there is a "click" sound.

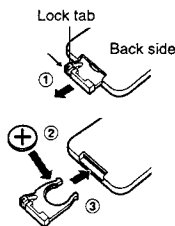

The Battery

- Observe the following precautions since incorrect use can cause the battery to rupture.
 - Do not cause the battery to short-circuit and do not disassemble or heat the battery.
 - Do not throw the battery into a fire.
 - When replacing the battery, insert it properly and do not mistake the (+) direction.
 - Dispose of used batteries in established places.
- Keep the battery out of the reach of children so that it is not swallowed by mistake.

Viewing TV Broadcasts

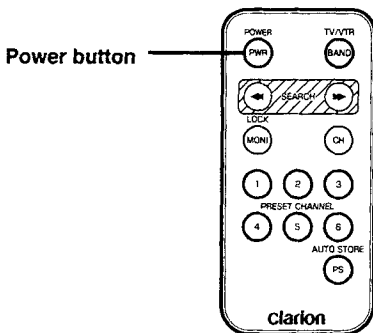

Switching Off the TV

Depress the power button for at least 1 second to switch off the picture.

A press of the power button sets the TV mode and a picture appears.

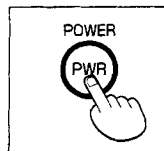

For radios that have preset memory, it will be convenient to preset the channel of the FM radio to 88.7 MHz or 88.3 MHz in advance.

For information about the 88.7 MHz and 88.3 MHz adjustments, see the Frequency Switch section on Page 12.

Adjusting the Volume

For FM Modulator Wiring:

- 1 Switch on the power of the car stereo (or FM radio).
- 2 Tune to 88.7 MHz or 88.3 MHz with the tuning knob of the car stereo (or FM radio).
- 3 Set the desired volume with the volume control of car stereo (or FM radio).

●For Deck Wiring

Set the desired volume and tone with the volume and tone controls of the source unit.

Warning!

For rear seat use only. Do not install on dashboard or anywhere else that would permit monitor to be viewed by the driver. Monitor must never be used in any manner that will distract driver or interfere with driver's safe operation of the motor vehicle.

Storing Channels to Preset Memory

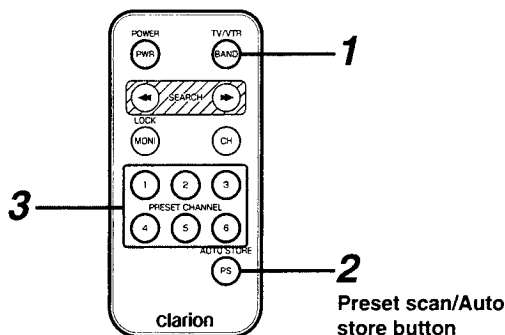

Auto Store

The auto store function stores the automatically received channel to a preset channel automatically.

Setting Automatic Storage (Auto Store)

1 Press the band button and select TV1 or TV2.

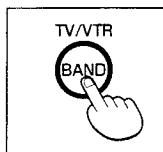

The method of preset memory storage is the same for TV1 and TV2.

2 Depress the preset scan/auto store button for at least 1 second to automatically store the received broadcast station and display the condition.

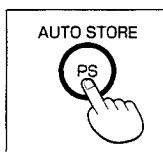

Storage is to the channel side from the currently received channel.

● Changing Preset Memory

3 Select the channel that is to be changed and depress the preset channel button for at least 1 second to display the pressed preset number in white characters and store the new channel being received.

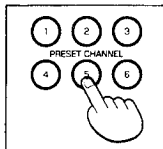

Checking Preset Memory (Preset Scan)

Press the preset scan/auto store button to display the broadcasts of the stored channels in order for 5 seconds each.

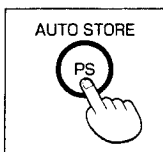

Stopping the Preset Scan

Press the preset scan/auto store button once again.

Preset Memory

The number of channels for which preset memory can be used total 12: 6 stations for TV1 and 6 stations for TV2.

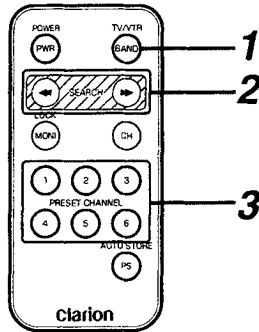

Setting Preset Memory

- 1 Press the band button and select TV1 or TV2.

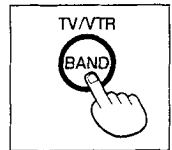

- 2 Select the channel to be preset with the channel button.

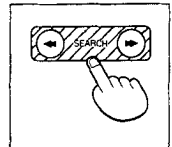

- 3 Depress the preset channel button for at least 1 second to display the pressed preset number in white characters and store the new channel being received.

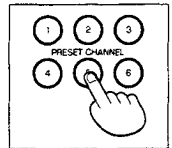

After completing the preset memory operation, press the preset scan/auto store button to allow viewing of the stored channels in order. (Preset scan)

Station Selection

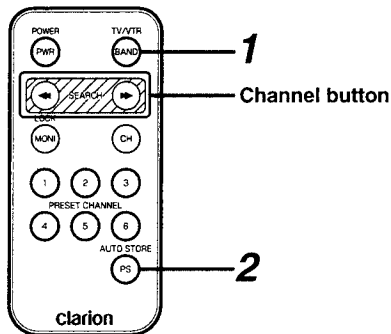

Reception channels are
VHF CH. 2 to 13
UHF CH. 14 to 69

Number of memory pre-sets total 12

TV1: Memory for 6 stations

TV2: Memory for 6 stations

Preset Station Selection

- 1 Press the band button and select TV1 or TV2.
- 2 Press the preset channel button. Each time the button is pressed, the stored channels are selected in order of channel storage.

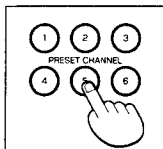
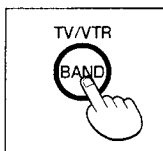

For more information about the method of preset memory, see the Storing Channels section (on Pages 21 and 22).

Manual Station Selection

Press the channel button

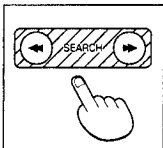

Each press of the channel button increments the number of the channel by 1. The channel button will go off in about 5 seconds.

Automatic Station Selection

Depress the channel button for at least 1 second to set the automatic channel selection mode. There will be an automatic stop at the channel on which the broadcast is received.

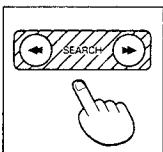

When the automatic station selection has stopped before or after a broadcast channel, press the channel button once again.

Viewing a Video

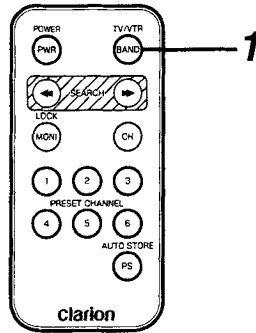

Set to VTR1 when the connections go to video/audio input jacks 1, and set to VTR2 when the connections go to video/audio input jacks 2.

For information about the operation method of the video equipment, see the owner's manual of the connected equipment.

- 1 Press the band button and select VTR1 or VTR2.

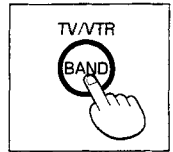

- 2 Start playback of the video equipment.

Convenient Functions

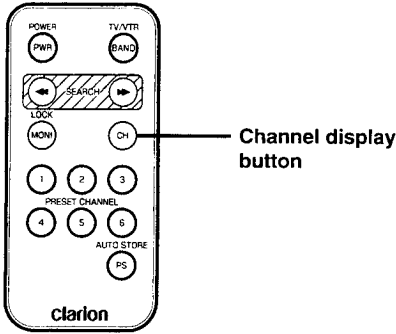

When You Want To Know the Channel

Press the channel display button to display the band at the top left of the screen, and the current channel and audio mode at the top right of the screen.

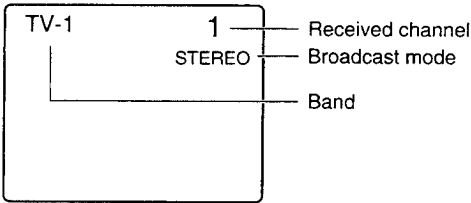
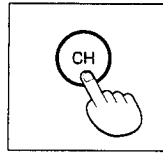

The display goes off in about 5 seconds.

ScreenDisplay	Broadcast Mode
Blank	Monaural broadcast
STEREO	Stereo broadcast
MONO	Reception by forced monaural

The various displays will change automatically depending on the broadcast mode.

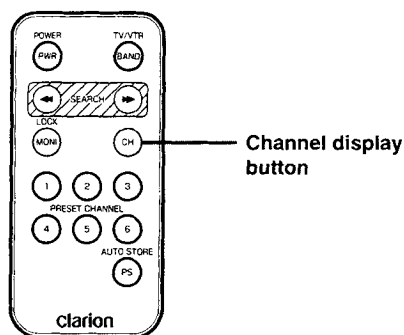

Switching the Stereo Broadcast Mode

- 1 Press the channel display button to display the channel and other information on the screen.

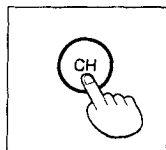

- 2 When the channel is displayed, each press of the channel display button will switch the audio mode as indicated below.

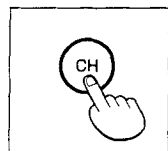

When it is Difficult to Hear the Broadcast

Since the stereo broadcast area is small, there may be prominent noise, or there may be frequent switching between stereo and monaural. Should this be the case, set the broadcast mode to MONO to enjoy better quality reception.

Monaural broadcast	Blank ↔ MONO
Stereo broadcast	STEREO ↔ MONO

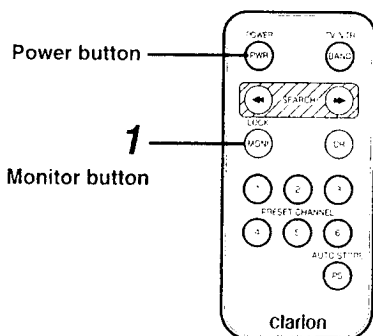

Monitor Lock

The monitor lock function allows the audio to be set to cassette tape, radio, CD, or MD play while the TV or video screen is unaffected.

Setting the TV for Use as Background Video (Monitor Lock)

1 Depress the monitor button for at least 1 second to set only the audio to the mode which existed prior to watching the TV while the TV screen is unaffected.

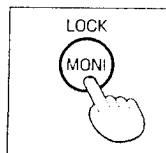

2 The source unit is used to select or adjust the desired listening mode.

●Cancelling Monitor Lock

Press the power button to return the system to TV audio.

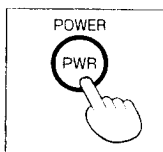

The monitor lock function cannot be used with FM modulator wiring. (See Page 12 for details about system wiring.)

For information about mode switching and operation methods, see the owner's manual of the source unit.

Switching Off the Monitor Screen (Monitor Off)

Switching Off the Monitor Screen (Monitor Off)
Press the monitor button to switch off the picture and leave the TV audio.

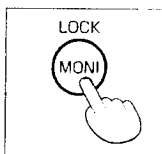

●Cancelling Monitor Off

Press the monitor button once again.

Troubleshooting

Please check the following points one more time before requesting repair service, when there is a problem.

Symptom	Cause	Measures
No power	Blown fuse Incomplete wiring	Replace with a new (5 A) fuse. If the fuse blows after replacement, please contact your store of purchase.
	Poor reception conditions	Read about the wiring method again and wire correctly.
Picture is unclear	Poor reception conditions	There may be an insufficiently strong signal arriving due to being in the shadow of mountains or buildings. Check again in a location exposed to a stronger signal.
Picture is double or triple	There is an interfering broadcast	The signal might be reflected from mountains or buildings. Check by changing location or direction.
Picture has a flecked or lined pattern	Frequency of FM radio is not matched.	There may be effects from cars, trains, neon signs (or other interfering signals). Check by changing location.
No sound	(Only for FM modulator wiring)	Check that the frequency of the car stereo is matched. (88.3 MHz or 88.7 MHz)
A control does not function	Incorrect setting of position switch	Check whether the setting matches the details of the wiring.

Specifications

● Main Unit

Power supply voltage:	14.4 V
Ground system:	Negative ground
Current drawn:	0.8 A or less (2.0 A or less with the VMA9181 monitor connected)
External dimensions:	204 mm (W) x 30 mm (H) x 200 mm (D)
Weight:	1 kg

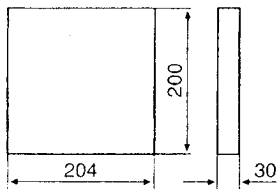

Reception channels:	VHF CH. 2 to 13 (54 to 216 MHz) UHF CH 14 to 69 (470 to 806 MHz)
Antenna input:	75 unbalanced

● Card Remote Control

(Infrared type wireless remote control packaged with the FM modulator accessory package for the TV tuner (RCB-062-600))

External dimensions:	40 mm (W) x 6.5 mm (H) x 68 mm (D)
Weight:	Approximately 18 g

*Specifications and design are subject to change without notice for the purpose of improvement.